

HM126 WOODLANDER: OVERALL DIMENSIONS

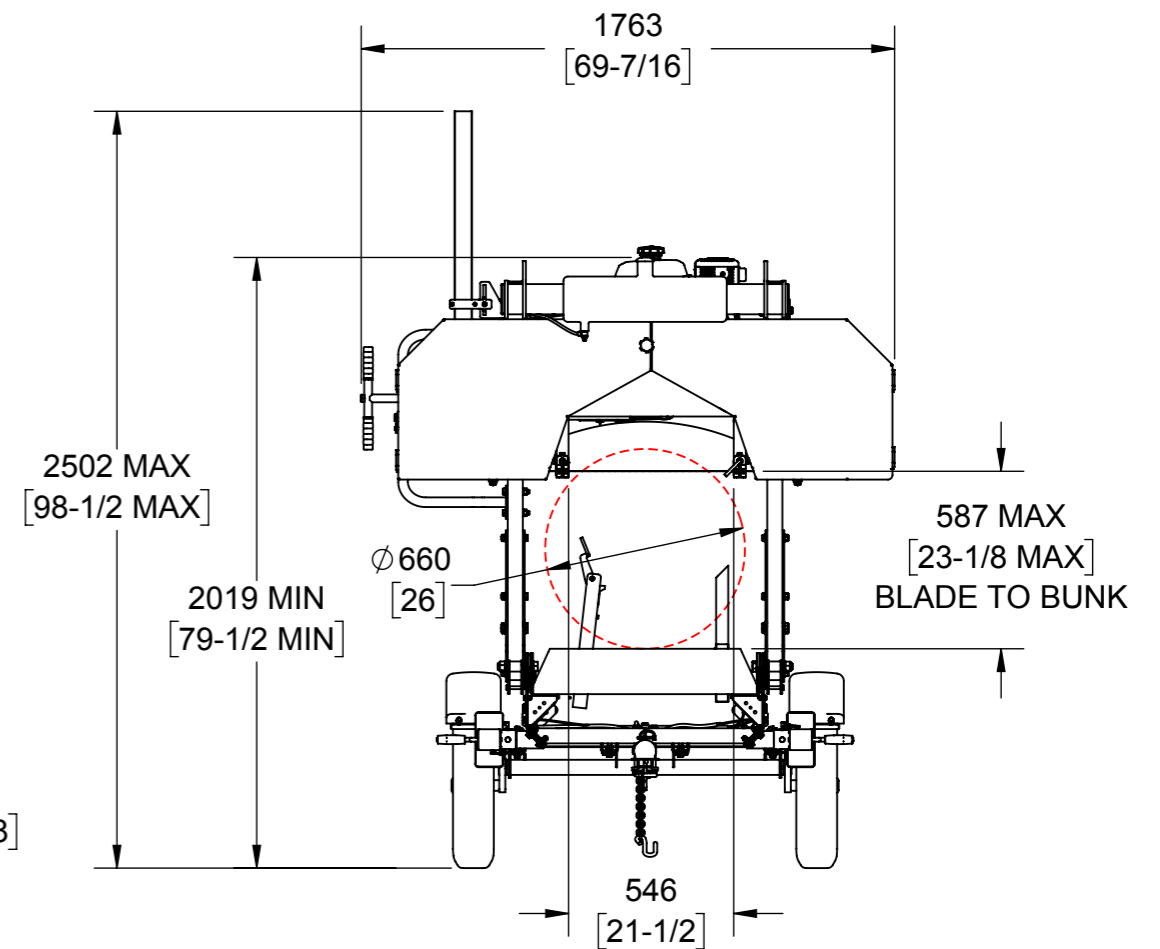

NOTES:

1. DIMENSIONS LOCATED WITHIN SQUARE BRACKETS [] ARE IN INCHES.

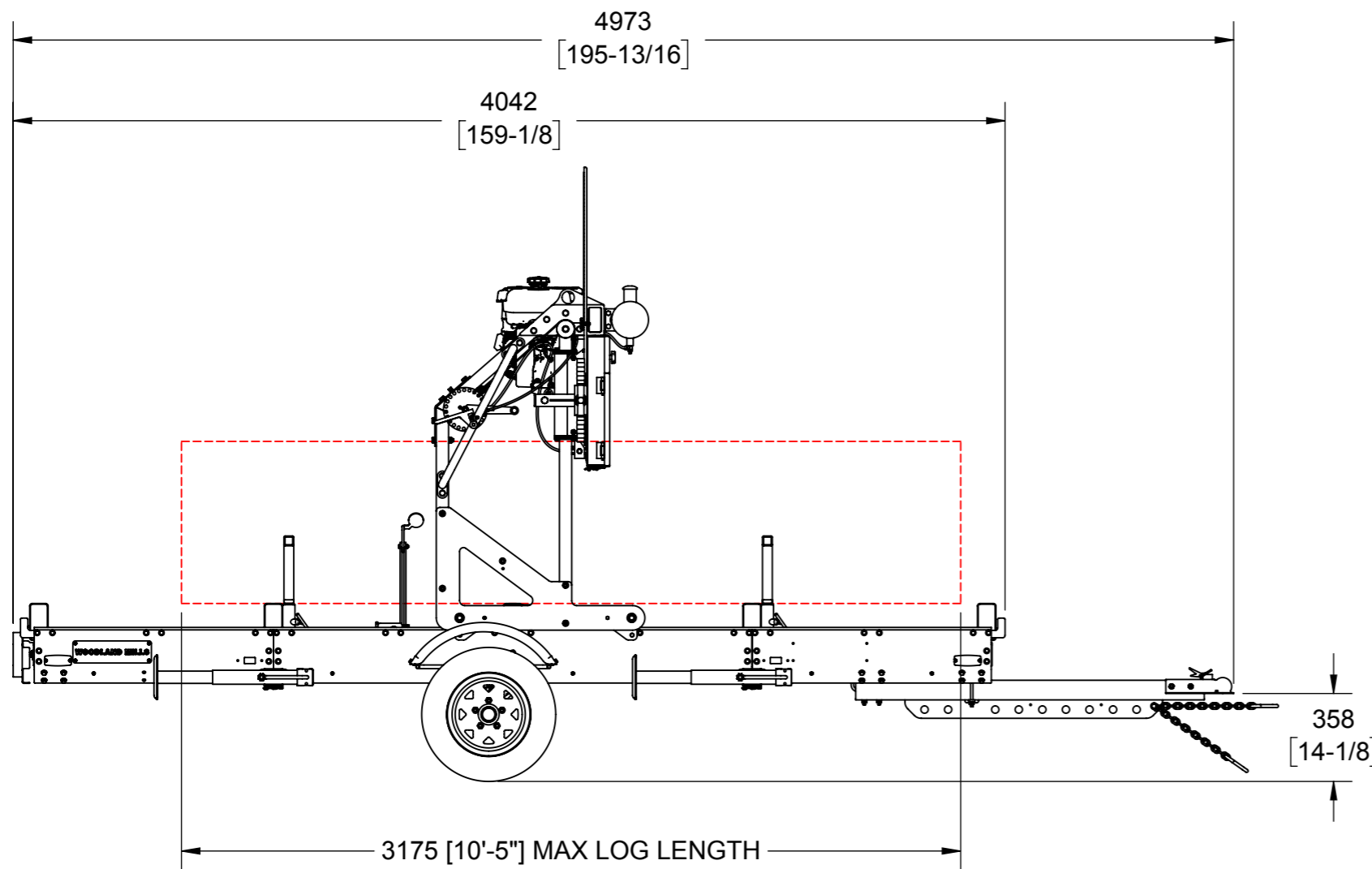
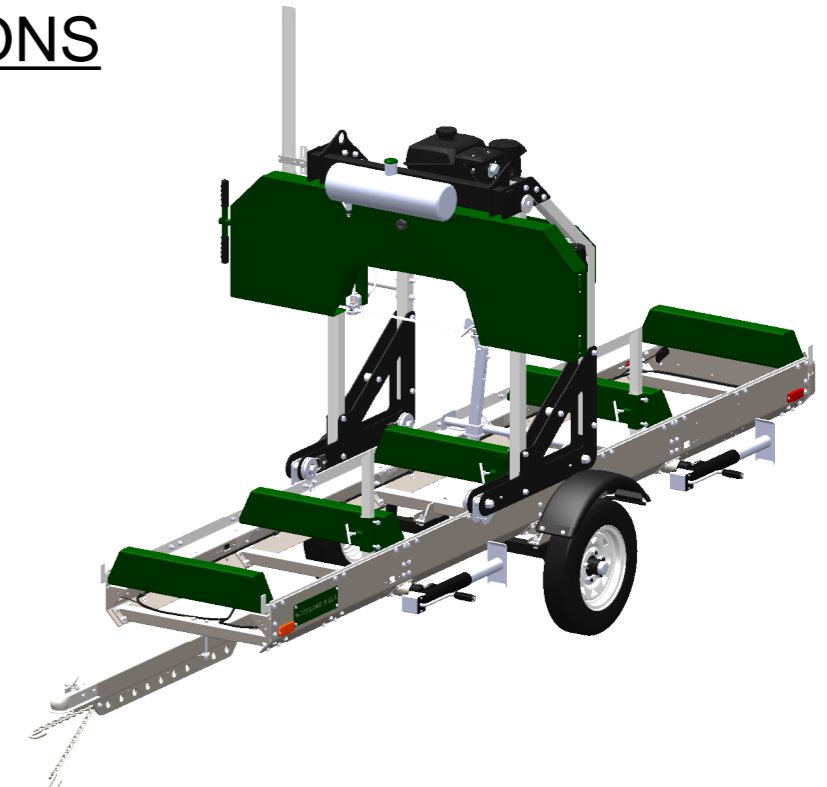
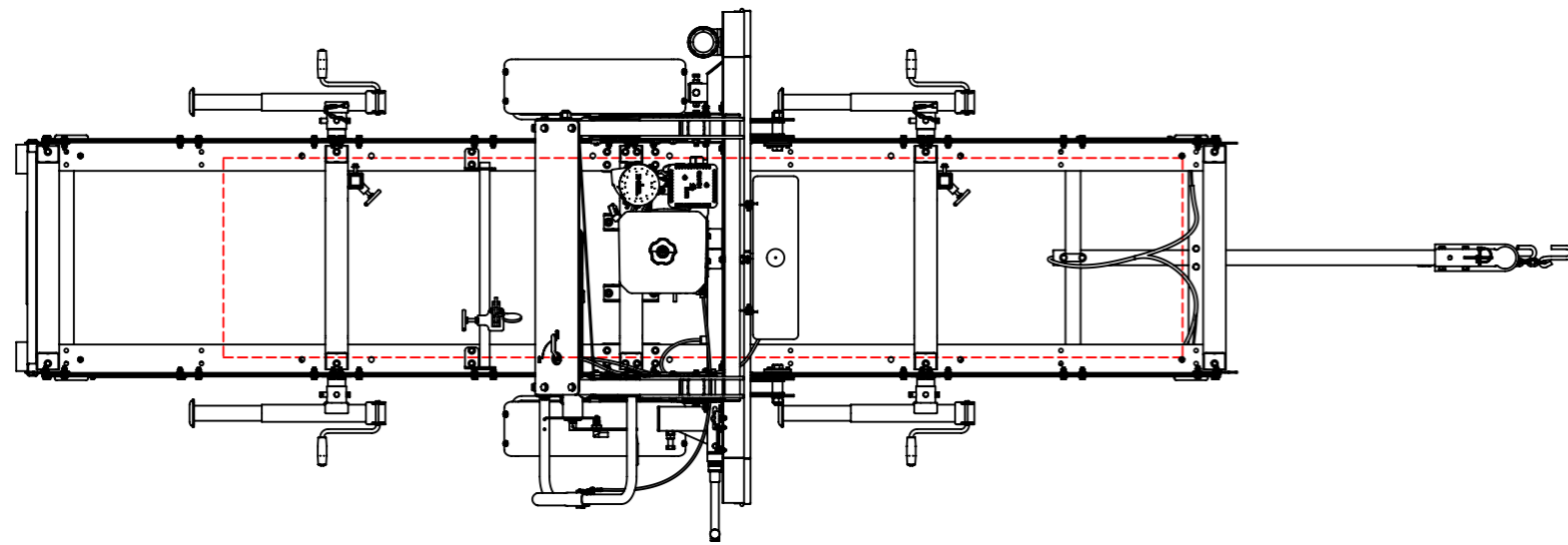

WOODLAND MILLS FORESTRY EQUIPMENT
171 NORTH PORT RD, UNIT #1
PORT PERRY, ON L9L 1B2, CANADA
1 (855) 476-6455

SIZE A3	DWG NO	REV
SCALE 1:25	DATE 12-11-2018	SHEET 1 OF 1